



1ST-LABS GROUP CO.,LTD

Incubation Investment
Electronic R&D Engineering Service



About 1ST-LABS

1ST-LABS



Focus on Electronic R&D Engineering Service

Improve R&D and MP quality/efficiency

**TÜV Certified
Professional operation management**

**Focus electronic incubation investment
supporting platform**

More than 6000+ customers worldwide

Famous customers: 6000+ in wide field

1ST-LABS





1ST-LABS Quality System and Focus Filed

1ST-LABS



ISO13485

Medical

TÜV IATF16949

Automotive

TÜV ISO9001

Quality

TÜV ISO14001

Environmental



Medical Electronic



Automotive



Industrial Control



Semiconductor



1ST-LABS Technology Group

1ST-LABS



incubation & RD Service platform
investment management

EECraftsman Technology



Craftsman

Products Design, Embedded system, PCB Layout, Products Optimize

Focus-Talents Consultant



Focus-Talents

Technical Experts
Human Resources

KnowHow Technology Co.,Ltd



KnowHow-Tech

PCB, Components, Pilot Run/MP
SMT/PCBA, Testing, BGA Rework,
CNC, Tooling, Product
Manufacture

IP-Plant Management



IP-Plant

IP Application & Management
High-tech enterprise identification
and innovation fund consultant

1ST-LABS operation location

1ST-LABS



R&D Center



Operation
Headquarter



MP
Factory

Xi 'an R&D Branch

1ST-LABS



Xi 'an Yanta District
Greenbelt Blue Sea
Building L16



Reception



Office Area

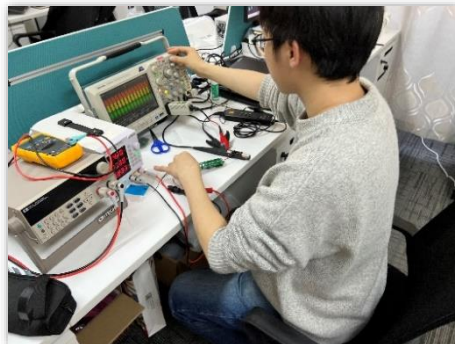

Laboratory

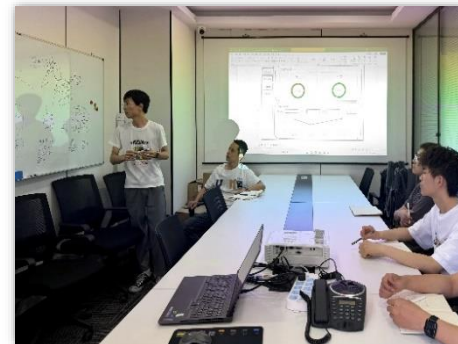

Meeting Room

创馨科技1ST-LABS 电子研发工程服务

1ST-LABS



Product define

Product research & development

Product mass production

Product delivery and maintenance



R&D Cycle Phase

MP, go to market, after-sales maintenance

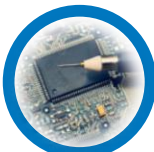

Hardware Schematic Design



Embedded Software

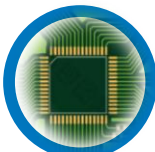

PCB Layout



PCB Production



Component Purchasing



R&D SMT Pilot Run



Quality Control



Chip Authenticity Comparison Library



PCBA Mass Production



Testing Assembly

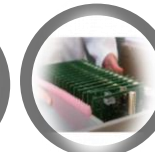

Packaging Logistics



Product Development



Encryption Protection

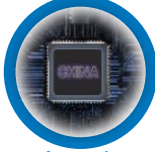

Alternative Design



BGA Reballing



BGA Fly wire



BGA Rework



3D Printing



DFT/DFM



Aftersales Repair Service



Component Analysis

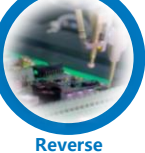

Reverse Engineering



R&D Tools

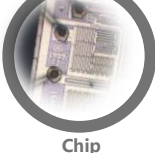

Chip Decap



Entrepreneurship Resource Management



Technical Expert Service



CNC Machining



IP Consultant



High-tech Enterprise Application consultant

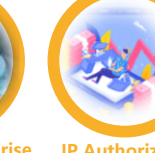

IP Authorization Management

创馨科技1ST-LABS 电子研发工程服务

1ST-LABS



Product define

Product research & development

Product mass production

Product delivery and maintenance



R&D Cycle Phase

MP, go to market, after-sales maintenance

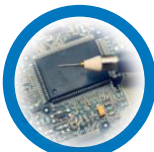

Hardware Schematic Design



Embedded Software

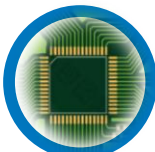

PCB Layout



PCB Production



Component Purchasing



R&D SMT Pilot Run



Quality Control



Chip Authenticity Comparison Library



PCBA Mass Production



Testing Assembly

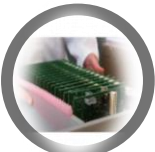

Packaging Logistics



Product Development

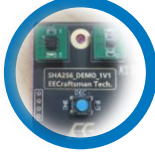

Encryption Protection

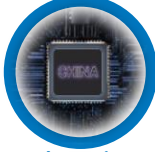

Alternative Design



BGA Reballing



BGA Fly wire



BGA Rework



3D Printing



DFT/DFM



Aftersales Repair Service



Component Analysis



Reverse Engineering



R&D Tools



Chip Decap



Entrepreneurship Resource Management



Technical Expert Service



CNC Machining



IP Consultant



High-tech Enterprise Application consultant



IP Authorization Management



[More Details](#)

1ST-LABS – Quality Control

1ST-LABS



R&D process management

Schematic design
Wrapper library specification
PCB layout and wiring

01

STEP

Material quality control

PCB processing
Component procurement
Production consumables procurement



02

STEP



Quality Control

STEP

04

Production-manufacturing

Production process management
SOP and process control
Functional and performance testing



STEP

03

DFT/DFM

Design for testability
Design for manufacturability
System process optimization



Participate in R&D, and get involved in process of optimizing in advance

Control the whole process from parts to production process

Participate in designated ICT and FCT test programs

TÜV management system, excellent yield rate

Provide high quality delivery at low total cost

1ST-LABS – Chip Authenticity Comparison Library

1ST-LABS



Establishment of authentic database

Device screen printing model comparison

Device thickness comparison

X-Ray structure comparison

Decap silicon chip comparison

Comparison of pin impedance measurements

Device function and performance test

芯片真伪对比库

序号	规格型号	品牌	封装	批次	标准丝印图正面	标准丝印图反面	X-ray结构标准图	Decap标准图	阻抗表	规格书
20	ADS1118IDGSR	TI(德州仪器)	SSOP-10-0.5mm	2329+						
19	ADA4505-2ARMZ	ADI(亚德诺)	MSOP-8	2307+						
18	TPS73001DBVR	TI(德州仪器)	SOT-23-6	2329+						
17	MAX13487EESA+	亚德诺/MAXIM	SOIC-8	2407+						
16	ISO7221ADR	TI(德州仪器)	SOIC-8	2310+						
15	SN74LVC14APWR	TI(德州仪器)	TSSOP-14	2337+						
14	STM32F103C8T6	ST(意法半导体)	LQFP-48(7x7)	2332+						
13	NCV1117D33T5G	onsemi(安森美)	O-252-2(DPAK)	2402+						
4	BTS723GW	INFINEON	SOIC-14	2237						
1	AD9850BRSZ	DIGIKEY	28SSOP	2228						

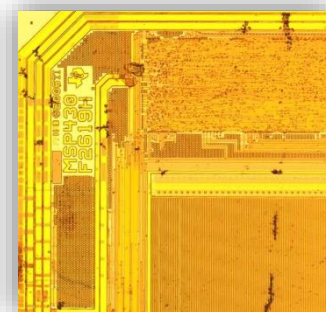
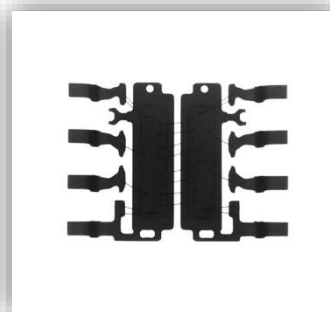
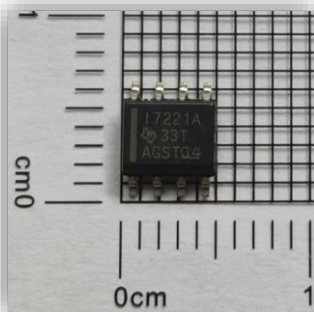

Function	Pin Number	Earth Impedance
Vbb	1	8.8MΩ
IN1	2	51.7KΩ
ST1	3	11.3MΩ
ST2	5	1.65MΩ
IN2	6	0.52KΩ
Vbb	7	8.7MΩ
Vbb	8	8.8MΩ
OUT2	9	∞
OUT2	10	∞
SPU	11	3.9MΩ
OUT1	12	∞
OUT1	13	∞
Vbb	14	8.8MΩ

EECraftsman – Hardware Schematic Design

1ST-LABS



MCU/ARM

Adopt leading ultra-low power architecture chip in this industry to achieve more robust and efficient interconnection, and develop products in industrial products, cloud connectivity, artificial intelligence and other fields to provide complete solutions.



FPGA

Provide one-stop services such as FPGA logic design, FPGA related circuit development, embedded system design, high frequency and high speed board, prototype or template and mass commissioned production.



HCI

Provide a wealth of human-computer interaction hardware and software design solutions, including resistance screen, capacitive screen, touch control, human-machine control interface, information feedback, actuator, etc.



DC/DC Power

Railway, traffic, harsh environment industrial control, ultra-low noise sampling system power supply, low noise and of medical equipment power supply product design, commissioning, certification, mass production one-stop service.

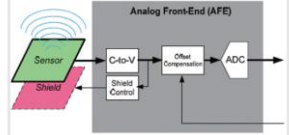

AFE

We have a wealth of sensor signal acquisition, small signal processing, low noise amplifier circuit, low delay, high precision reference source, high precision ADC sampling circuit R & D, design, manufacturing experience.

EECraftsman – Embedded Software Development

1ST-LABS



Embedded C

Verilog

Linux

FreeRTOS

QT

Programming Platform

PID

Motor Drive

Encoder

Motion Control

HMI

Algorithm Development

EECraftsman – PCB Layout

1ST-LABS

cādence

Altium
Designer.

Familiar with the essence of
DFT and DFM

Standard Design Lib
management system

Verify optimization in real
time on the production line

Exquisite Craftsmanship
Design Spirit



EECraftsman – PCB Layout

1ST-LABS

- 26+ layers of communication board
- F P G A
- C P L D
- D D R 4
- Low voltage and high current power supply

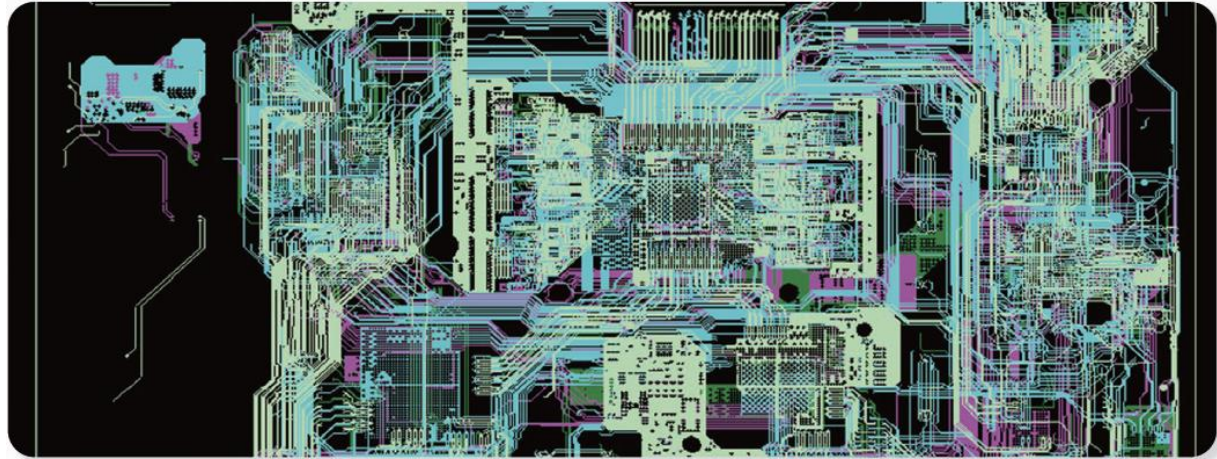

- HDI
- 8 layers of buried blind via
- Laser drilling
- High precision

0.33oz	1/3 O.Z.	1.1mil
0.33oz	106 (76%)	2.05mil
0.33oz	1/3 O.Z.	0.9mil
0.33oz	106 (76%)	2mil
0.33oz	1/3 O.Z.	1mil
0.33oz	106 (76%)	2.1633mil
0.5oz	0.19mm(0.16mm) HH	7.4mil (6.1)
0.5oz	106 (76%)	2.1633mil
0.33oz	1/3 O.Z.	1mil
0.33oz	106 (76%)	2mil
0.33oz	1/3 O.Z.	0.9mil
0.33oz	106 (76%)	2.05mil

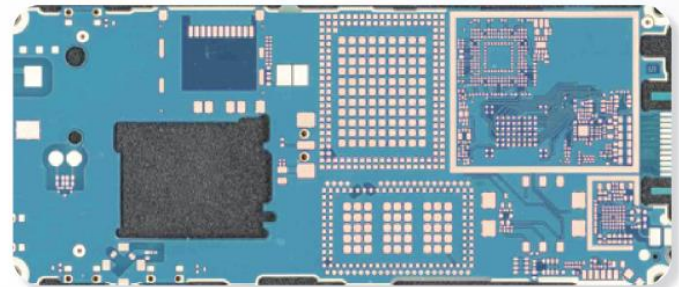



**Medical
Electronic**

- Precision stepping control system
- High performance, low noise LED light source
- Wireless data transmission within the organism
- Ultra-low power analog front end
- Software and hardware technologies such as sampling processing and algorithm optimization
- Wearable medical devices
- Ultra-miniaturization design and production



**Intelligent Vehicle
Transportation**

- Component selection and redundancy design
- Stability and reliability design
- Three defense and reinforcement
- Hardware and software redundancy
- PCB EMI optimization processing
- Encryption and security
- Systematic integration and fool-proofing structure

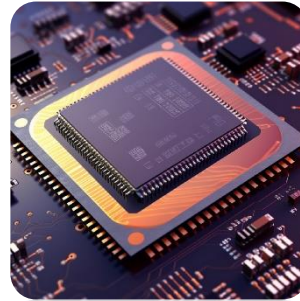

**Semiconductor
Chip**

- Wafer Scribing, fast package
- Bare die test board design
- Packaged test board design
- Test system PCBA
- DEMO board design
- Application development support
- Module design and batch delivery



**Industrial
Control**

- Sensor optimization
- Wired transmission interface
- Wireless transmission interface
- Motor drive
- HCI interface
- Edge computing node
- Reliability and stability
- Tough environment prevention treatment
- CCC, UL, CE certification services

EECraftsman – SHA256 Encryption Solution

1ST-LABS

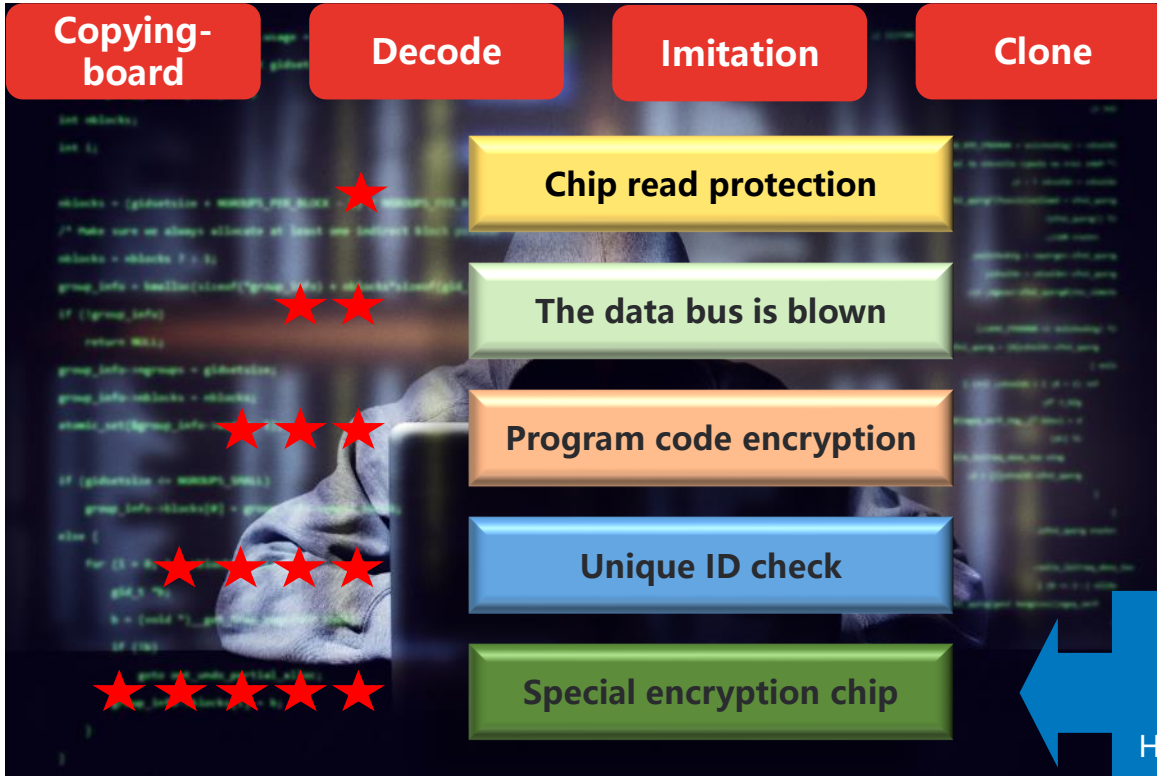

It is theoretically impossible to crack at present.

EECraftsman
Developed based on SHA256
Encryption Solution
Hardware chip + Algorithm library

EECraftsman – SHA256 Encryption Solution

1ST-LABS

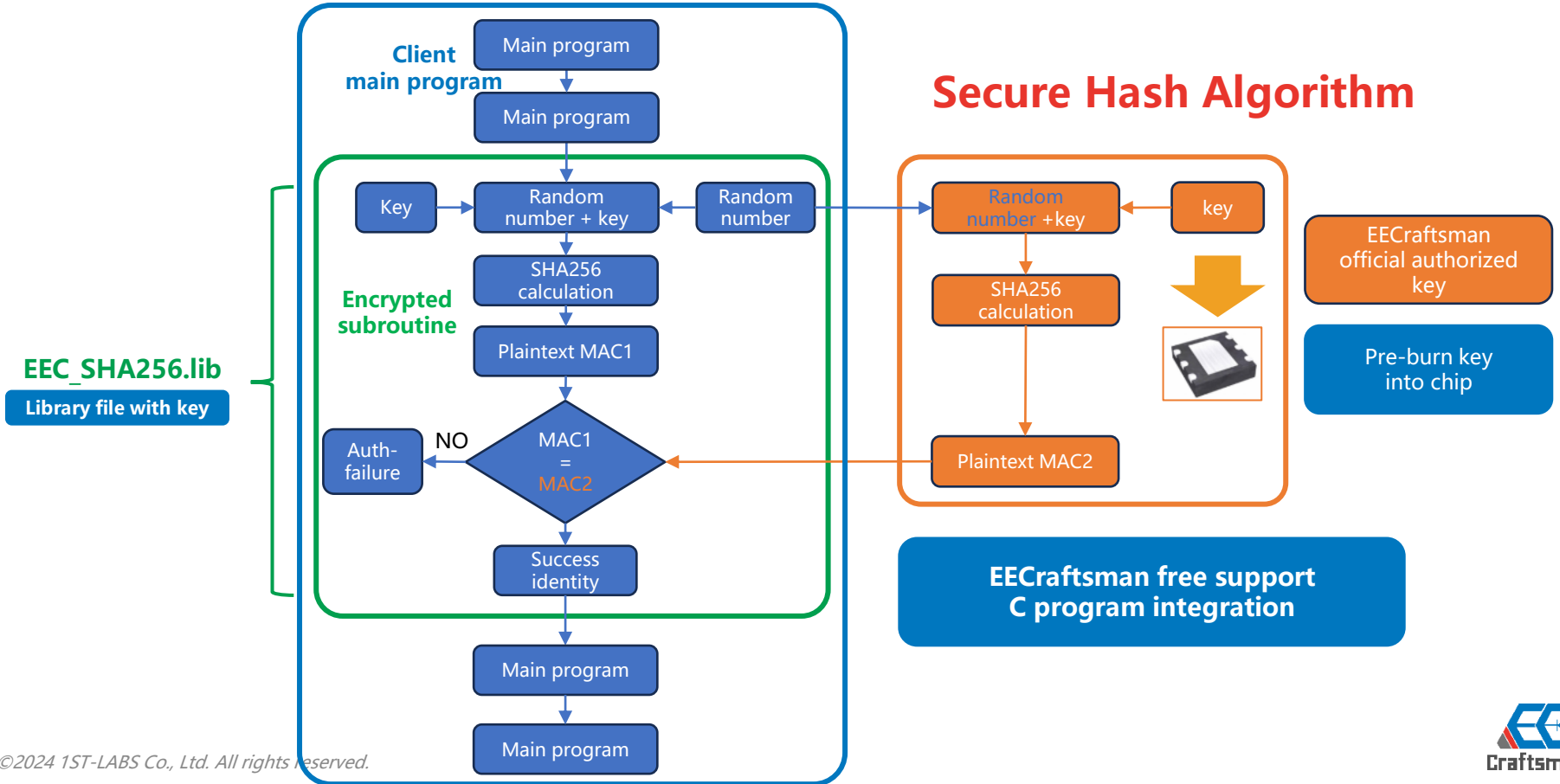

EECraftsman – Domestic Alternative Design

1ST-LABS



Reduce the overall product cost

Solve the shortage of material supply

Analog circuit domestic substitution

Digital circuit domestic substitution

Performance testing and verification

Domestic MCU code transplantation

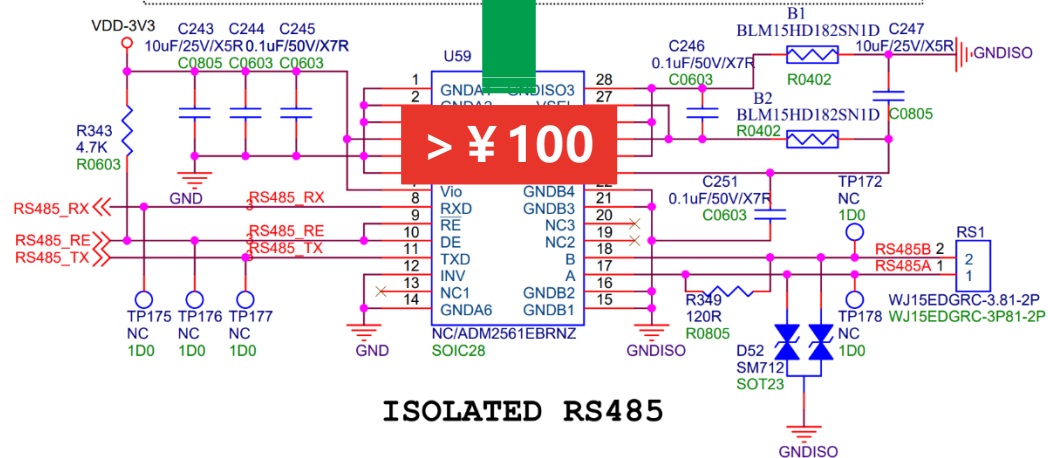
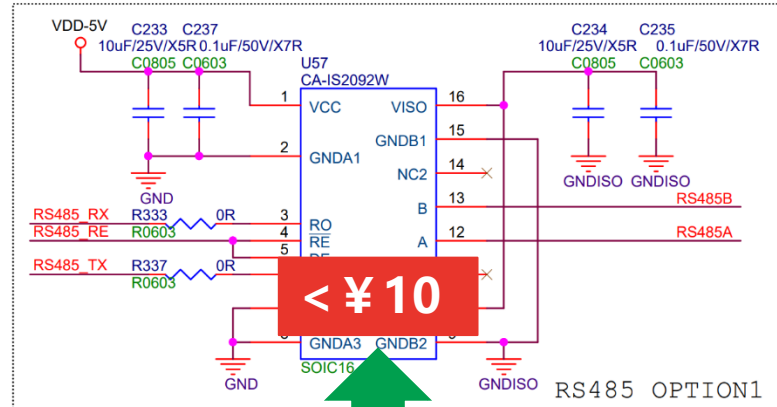

ISOLATED RS485

EECraftsman – Component Analysis

1ST-LABS

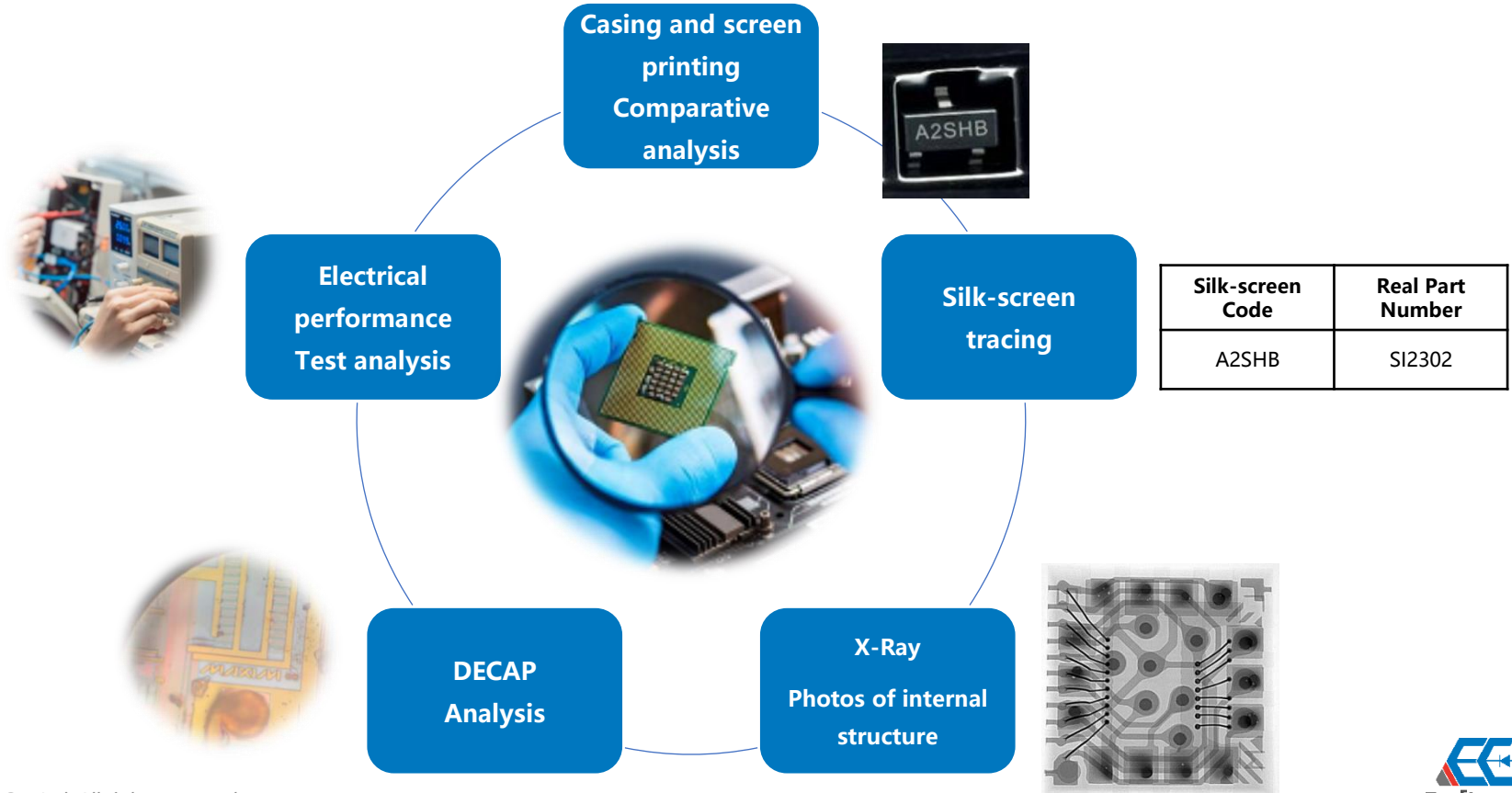

EECraftsman – Digital Reverse Analysis

1ST-LABS

Fine mechanical grinding
Laser scanning
Digital modeling



Build the library of schematics
Network reconstruction
Schematic backtracking

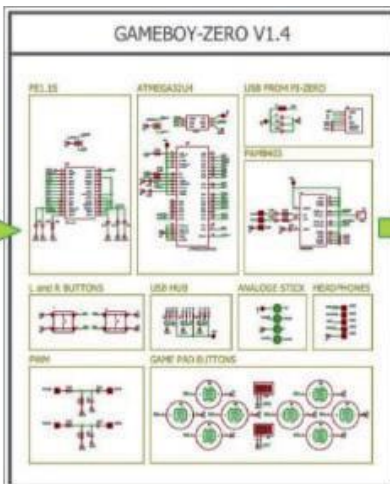

Rebuild Gerber
Reconstructed network table
Measuring component parameter



Chip silk-screen tracing
Chip DECAP analysis
Chip code read

**Customers are required to declare legal compliance with reverse analysis products
EECraftsman does not assume any legal risk or liability**

R&D RC Sample Kit



元器件盒整体规格：L28cm*W24.5cm*H4.2cm，



单元格规格：L2cm*W1.5cm*H2cm，可容纳0603封装的电阻3000多片。

Genuine
Article

Complete
Category

Spot
Stocks

Resistor
Series

0201

0402

0603

0805

1206

1% 128 Value (Single box) 0Ω-1M

5% 170 Value (2 boxes) 0Ω-10M

1% 484 Value All Series (4 boxes) 0Ω-10MΩ

Capacitor
Series

0201 52 Value 0.5pf-0.22μf

0402 68 Value 0.5pf-2.2μf

0603 73 Value 0.5pf-10μf

0805 66 Value 1pf-22μf

NR-2501



NR-2308

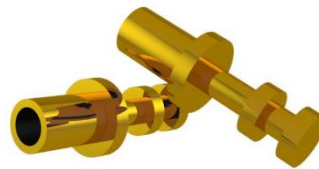

signal test point



Taobao Store

Focus-Talents – Entrepreneurship Resource Management

1ST-LABS



**Incubation Resource
Management Services**

Human resource trusteeship

Data center construction

Human resource ability assessment

Industrial policy and park policy

**Legal and arbitration dispute
handling support**

**Enterprise management system
consulting services**

TECHNOLOGY EXPERT



Expert Advisory Services
on Key Technologies

Low noise power supply

High precision ADC sampling

Low voltage high current DC/DC

EMI & EMC

Low power design for handheld devices

Failure analysis

Other expertise

1ST-LABS PCB Production

1ST-LABS

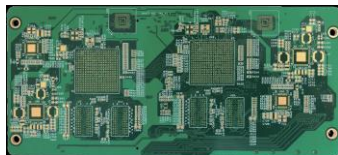

PCB manufacturing management expert

Field visits to certified partner factories

Factory scale

Precision of equipment

Quality system

Delivery speed

Technological level

Industry reputation

Determine matching plant according to design

Professional DFM process adjustment

Deal with PCB EQ

VIP customer cost control

Quality first fast delivery

Process Analysis



Quality Control



Delivery Management

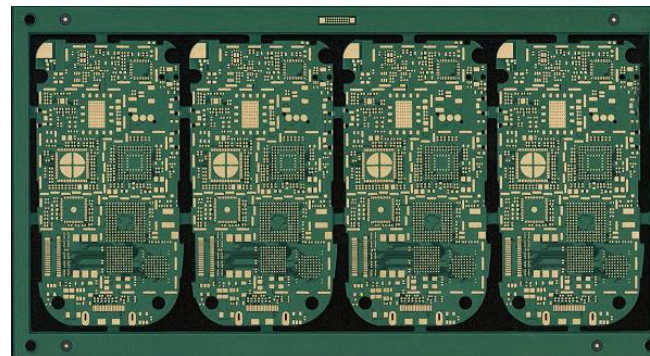

Up to 46 boards

High TG board

3mil Line width
Line distance

30:1 aspect ratio

HDI Blind buried hole

Rigid and flexible version

Up to 60Z copper thick

Max. 7mm plate thickness

Rogers high frequency plate

aluminum substrate

FPC board

impedance matching

1ST-LABS Component Purchasing

1ST-LABS

Conventional components,
spot stock

Authorised
Chanlel

4000+

Spot Stocks



Consignment
centralized
purchasing



Small batch/sample
distributor channel

High Volume agent
channel



KnowHow-Tech – R&D SMT Polit Run

1ST-LABS



A nut can also be cracked by a sledgehammer.

Intelligent flexible manufacturing technology

Standardized Quality Management System



Focus on Fast SMT Pilot Run



One-piece welding
No minimum consumption



Advanced technology
Professional quality



Fast delivery in 72 hours
Fast-Pass in 24 hours



ISO13485

TÜV ISO9001

TÜV ISO14001

TÜV IATF16949

Stencil-free paste technology
Intelligent adjustment of the thickness/area/size of tin spray



X-Ray Fast Point component



MYCRONIC MY700 Solder paste printing



Samsung 481 patch machine Feeder switch



Samsung 482 patch machine Feeder switch



ERSA14 Nitrogen reflow welding is supported in the warm zone

KnowHow-Tech – R&D BGA Rework & Fly Line

1ST-LABS

Fast repairment in 24 hours

IPC Certified maintenance technician

Remedy design errors

Shorten debugging time

Reduce R&D costs

Improve R&D efficiency

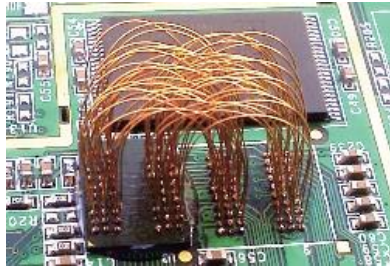

BGA Fly Line

BGA Inside flight , BGA leads outward

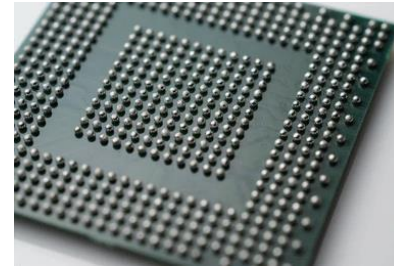

BGA Unsolder, reballing, rework

BGA, LGA, CSP, WCSP



DC rework workstation

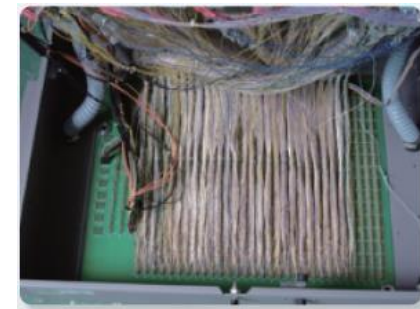

Case: IC test system, 28-layer PCB, thousands of lines, important core Socket non-destructive repair



Chip Part-Number Analysis

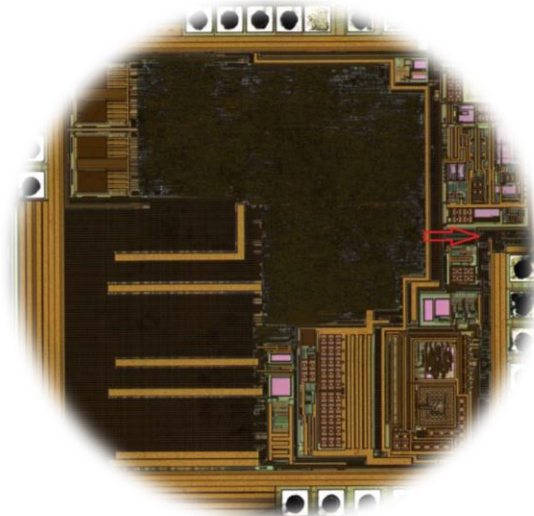
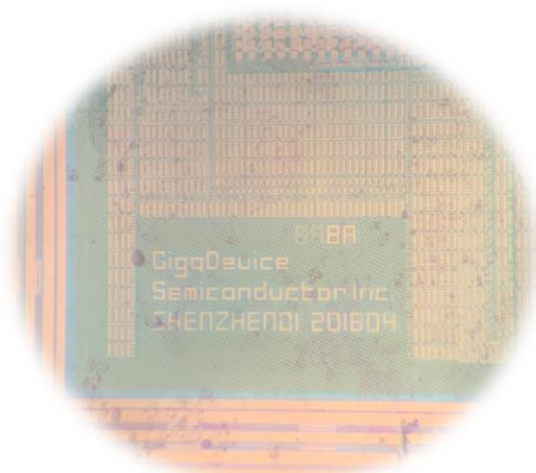
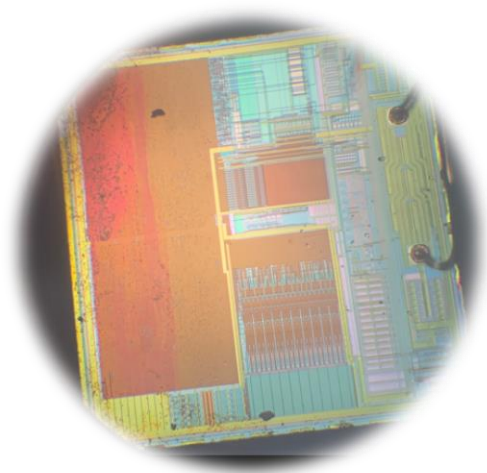

KnowHow-Tech – 3D Printing & CNC Machining

1ST-LABS

R&D 3D Printing & small-lot CNC

3D printer/Professional CNC Machining center (30 sets)



3D structure printing, size error $\pm 0.1\text{mm}$



CNC precision machining center, size error $\pm 0.02\text{mm}$



Mass production DFT/DFM optimization

Professional services from R&D to mass production

Manufacturability

Assembling ability

Yield of mass production

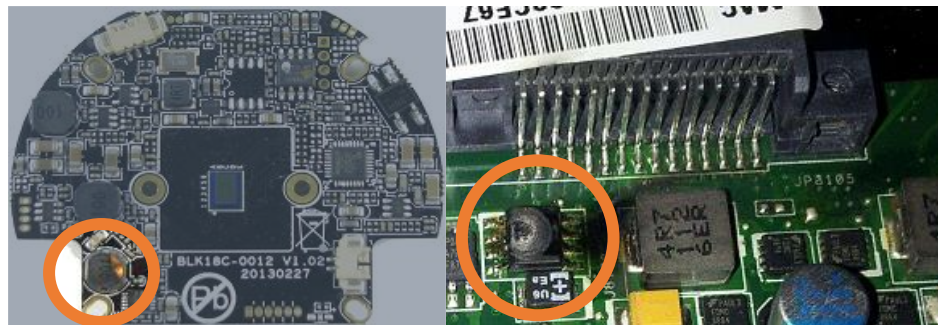

Failure analysis, ESD optimization, stress release optimization

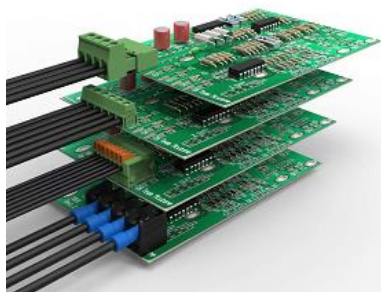

Assembly reliability optimization

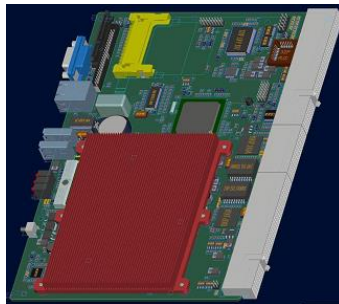

Structural process optimization



Batch production process DFT/DFM optimization, through rate and yield optimization

KnowHow-Tech – PCBA Mass Production

1ST-LABS



Standardized batch
manufacturing



TÜV ISO14001

TÜV ISO9001

Standardized Quality
Management System

TÜV IATF16949

ISO13485



X-Ray Point
component



GKG solder
paste printer



Solder paste printing
local optimization



SPI Solder
paste detection



JUKI chip
mounter



JT 12+3 zone nitrogen double track
reflow welding



AOI AOI
Detection



Wave-
soldering



First piece
detector



X-Ray
analysis

Daily full load mounting capacity of 1
million components

KnowHow-Tech – Testing & Assembly

1ST-LABS

Product Manufacturing

Standardized Quality Management System



TÜV ISO14001

TÜV ISO9001

TÜV IATF16949

ISO13485



Test fixture, fixture design and processing

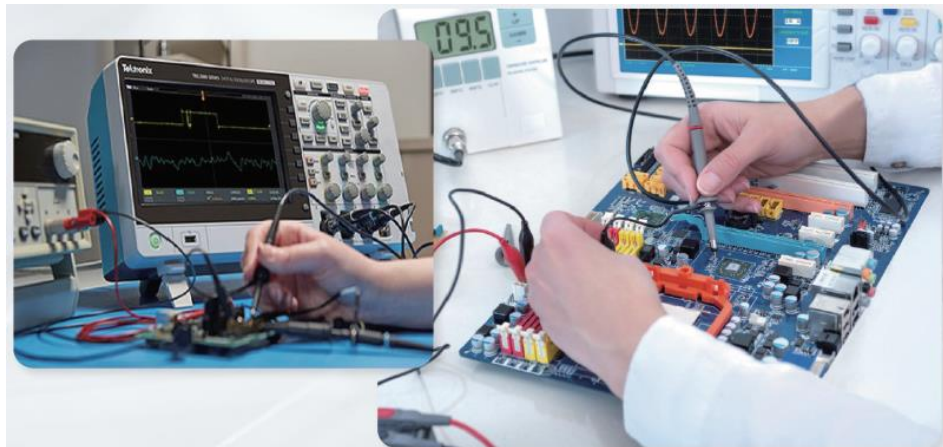

Performance Test



Product Assembly

KnowHow-Tech – Packaging & Logistics

1ST-LABS



Small and micro enterprises one-stop product package service

Packaging customization, warehousing management, logistics assistance



Batch board transfer framework, buffer material and packaging customization

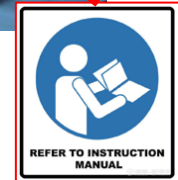

KnowHow-Tech – Aftersales Repair Service

1ST-LABS



Fault Analysis

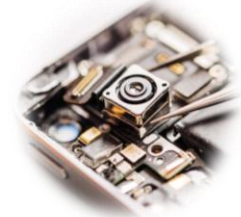
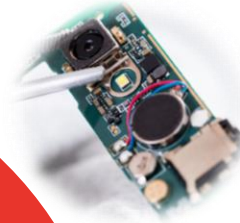

Batch Rework

Comparison of Schematic

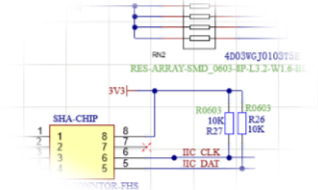

IPC Certified
maintenance technician

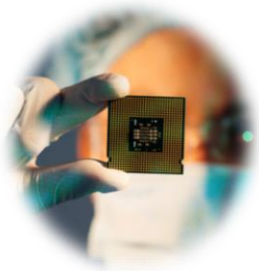

BGA Rework

Chip level
repair

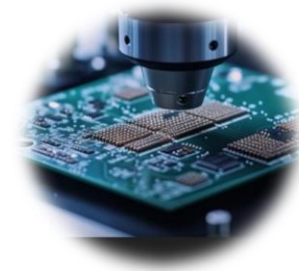

IP Plant - Intellectual Property Consultant

1ST-LABS

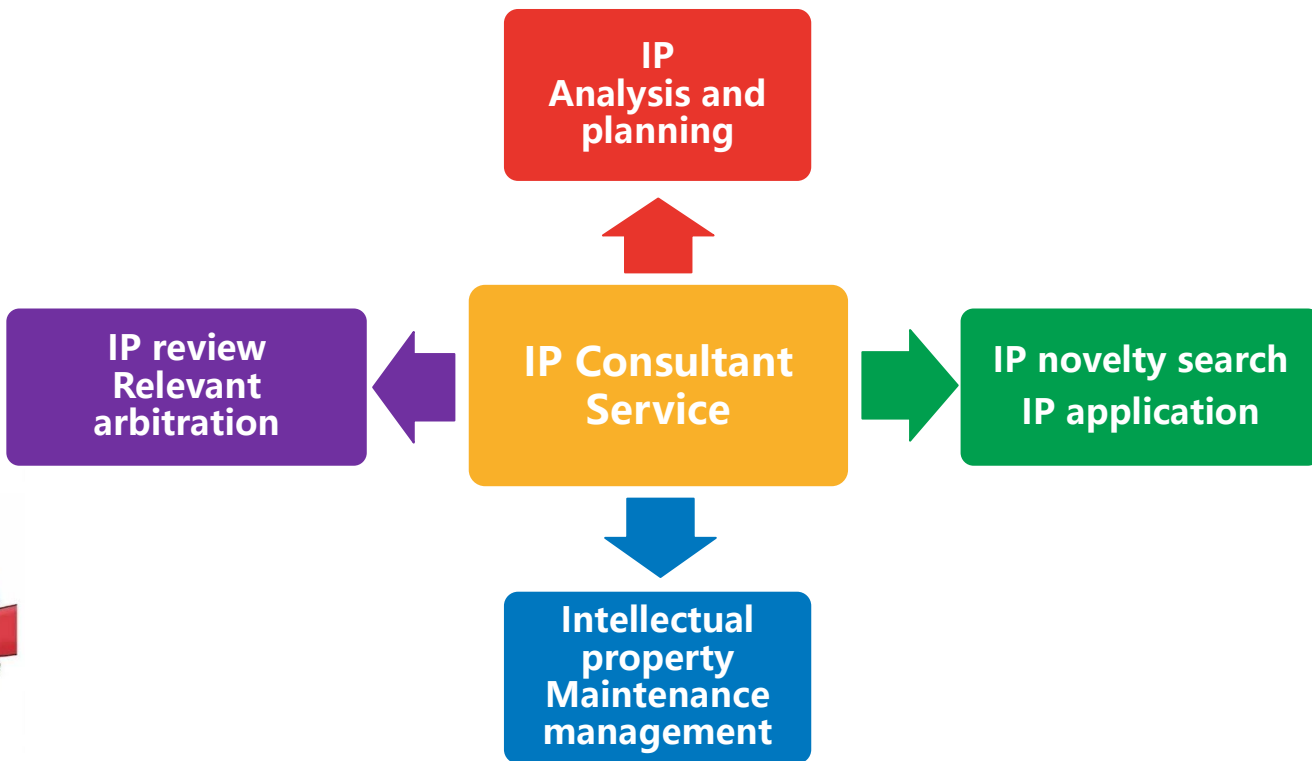

IP Plant - High-tech Enterprise Application consultant

1ST-LABS



Policy real-time interpretation

- Focus on real-time information
- Update policy interpretation

Intellectual property planning

- Patent mining and application
- Innovation management and planning

Declare qualification

- Guide the preparation of relevant materials
- Material compliance check

One-stop service

- Long-term development plan
- Full process consulting services

6-28 months IP application management » Apply for planning, apply for counseling, consulting services » Project increment

Registered Trademark

Appearance patent

Application for innovation fund

From 200,000

Promotion of Brand

Trademark design

Utility model patent

Application for high-tech enterprises

High-tech subsidies from 50,000

Tax Relief

Copyright

Patent for invention

Little Giant from 600,000

Financial Credit

Software copyright

Integrated circuit layout

IP Plant - IP Authorization Management

1ST-LABS



REFUND



CASH



CREDIT



BANK



SAVINGS



SIGNATURE



GOLD



INVESTMENT



VALUE



01

Value Planning

R&D phase
intervention planning
Apply for agency

02

Timesaver

Industry target customer
database
Accurate matching,
efficient and time-saving

03

Value return

Professional analysis
and valuation
Value maximization

04

Professional
management

Professional legal team
Professional management
team

Intellectual Property authorised management
consulting services

Intellectual Property trading
consulting services



Thanks !

创馨科技集团： 创业孵化及电子研发工程服务